

# Simorág DanCircus – Tale of the Mirror

Technical Rider



## **The Space:**

Stage width: 8 meters /minimum/

Stage depth: 8 meters /minimum/

Stage height: 4,5 meters /minimum/

Scenery should be fixed on the the sides of the space.

Drilled or tightend.

## **Sound:**

we have live music with acoustic instruments and playback sounds

we use sound system with microphones...

**Duration of the performance:** 50minutes

## **Installation time:**

Scenery: 3 hours

Light: 2 hours

Sound: 1 hour

Sound check: 1 hour

Warm up

(before the show): 1 hour needed

Dismantling time: 1,5 hour

## **Contact:**

**Bala Szabon**

+36702352571

szabonb@gmail.com

## **The members of the group:**

6 person (2x female, 4x male)

### Artists:

Ágnes Simor (female)

Bálint Turai (male)

Márton Vince (male)

### Musicians:

Réka Tóth Bernát (female)

János Vázsonyi (male)

### Technician:

Bala Szabon (male)

# Simorág DanCircus – Tale of the Mirror

Technical Rider (The Set)

black curtain

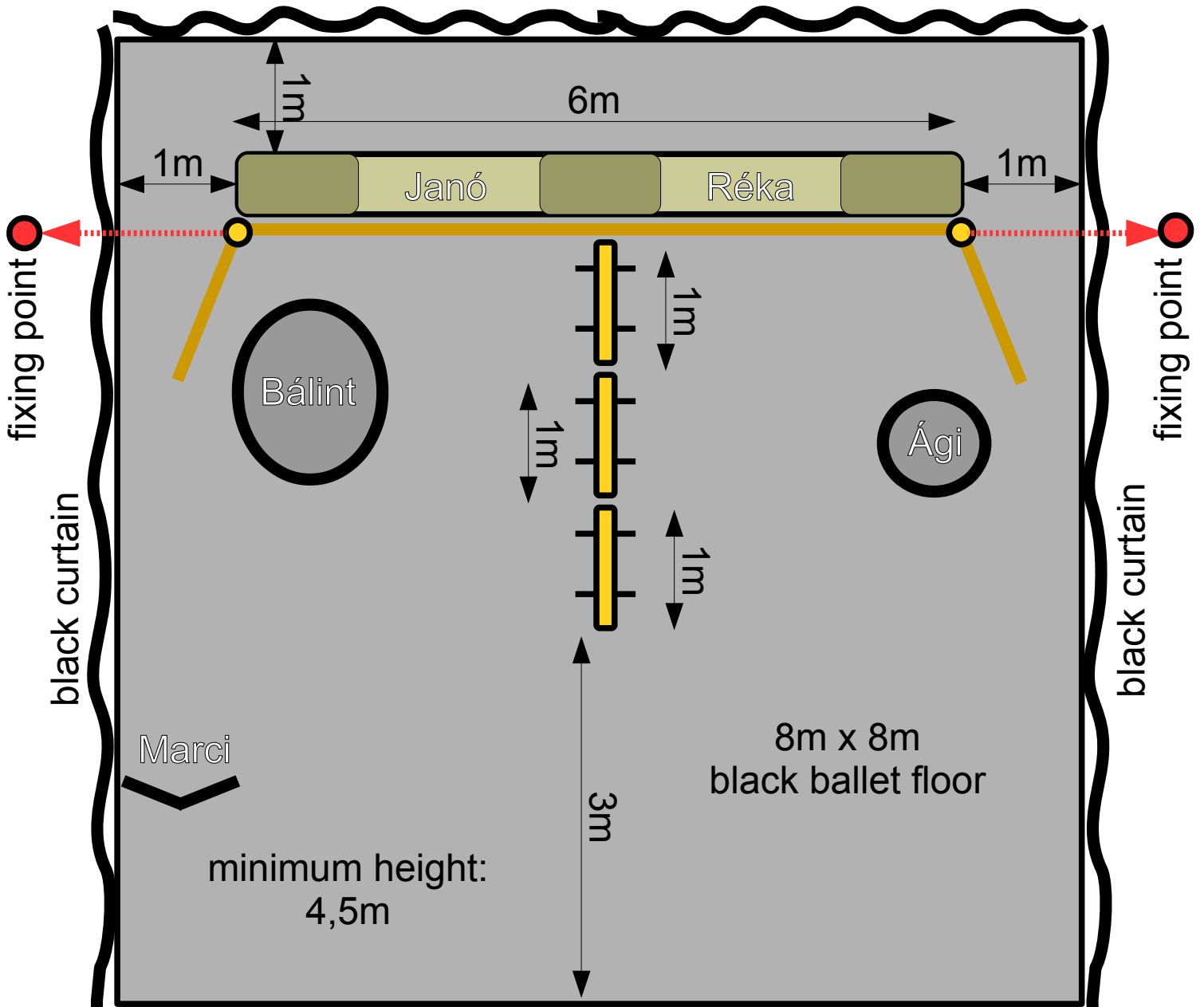

seats or pillows

for the audience

FOH  
Bala

# Simorág DanCircus – Tale of the Mirror

Technical Rider (Sound)

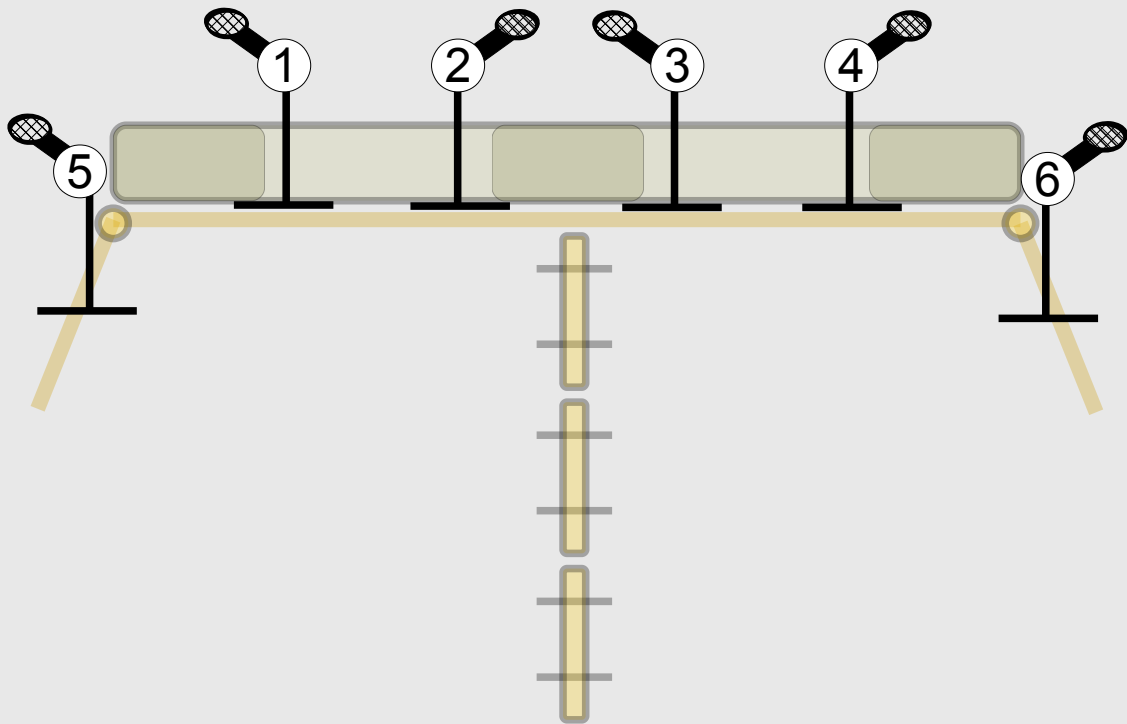

⑦ own wireless headset  
(on Marci)

6pcs. dynamic microphones  
(SM58, SM57)

6pcs. normal mic stands

Monitor  
Aux1

Monitor  
Aux2

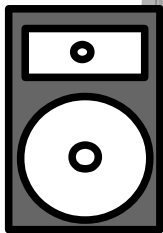

PA  
Left

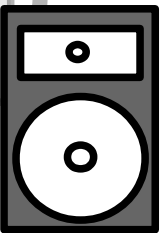

PA  
Right

## FOH:

7 mono channel for mic  
1 stereo channel for playback  
(or 1x stereo DIBOX + 3,5 Jack  
cable for a laptop)  
effects (reverb, delay)



# Simorág DanCircus – Tale of the Mirror

Technical Rider (Light) Floor

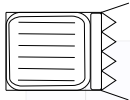
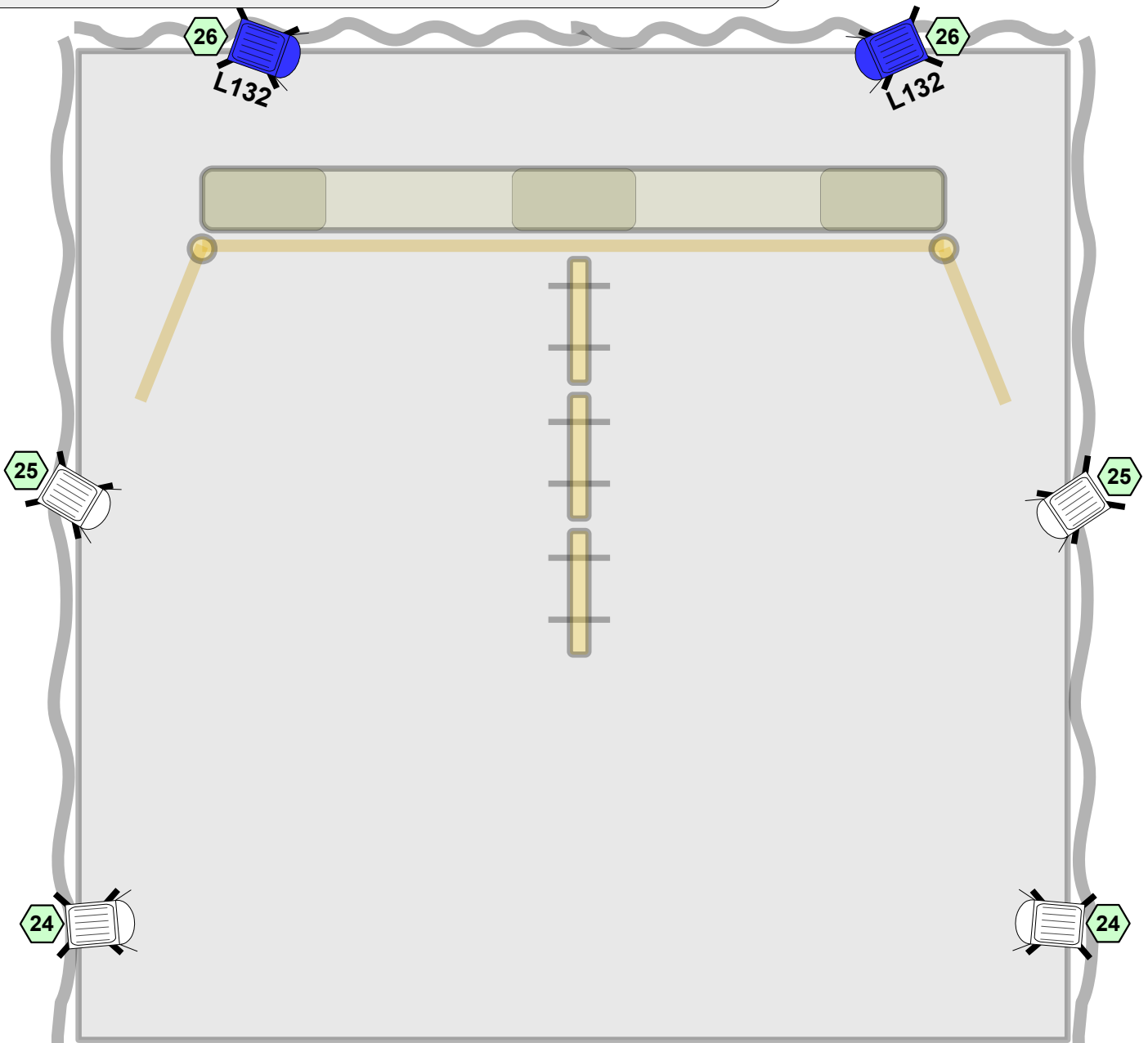

7pcs. **Fresnel 2kW**  
(with barndoor and frame)



20pcs. **PC 1kW**  
(with barndoor and frame)



10pcs. **Profil 1kW zoom 25-50**  
(with 2x goboholder, 2x iris, 2x frame)



10pcs. **RGBW LED Wash**  
1 (number of fixture group)



4pcs. **Symmetrical Flood** (for public)



6pcs. **Floor Stand**

27x **2kW Dimmer channel** 1

**Compulite Spark 4D** lighting desk  
or similar programmable lighting controller  
with minimum 20 submaster

# Simorág DanCircus – Tale of the Mirror

Technical Rider (Light) Simple

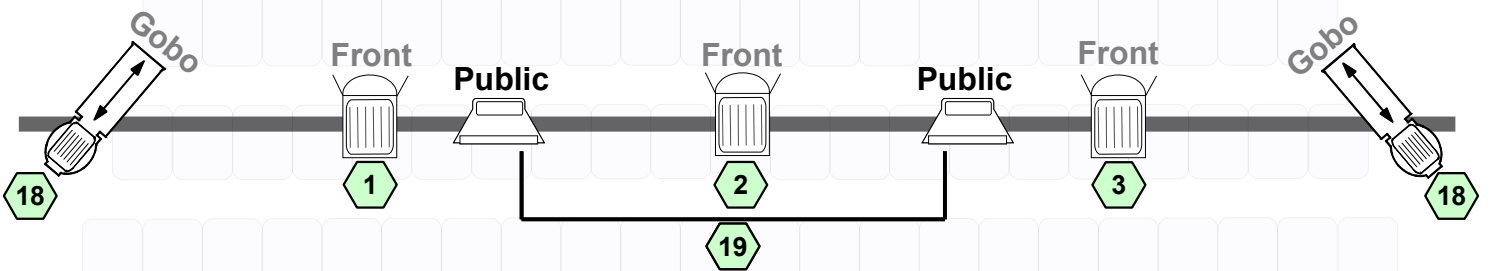
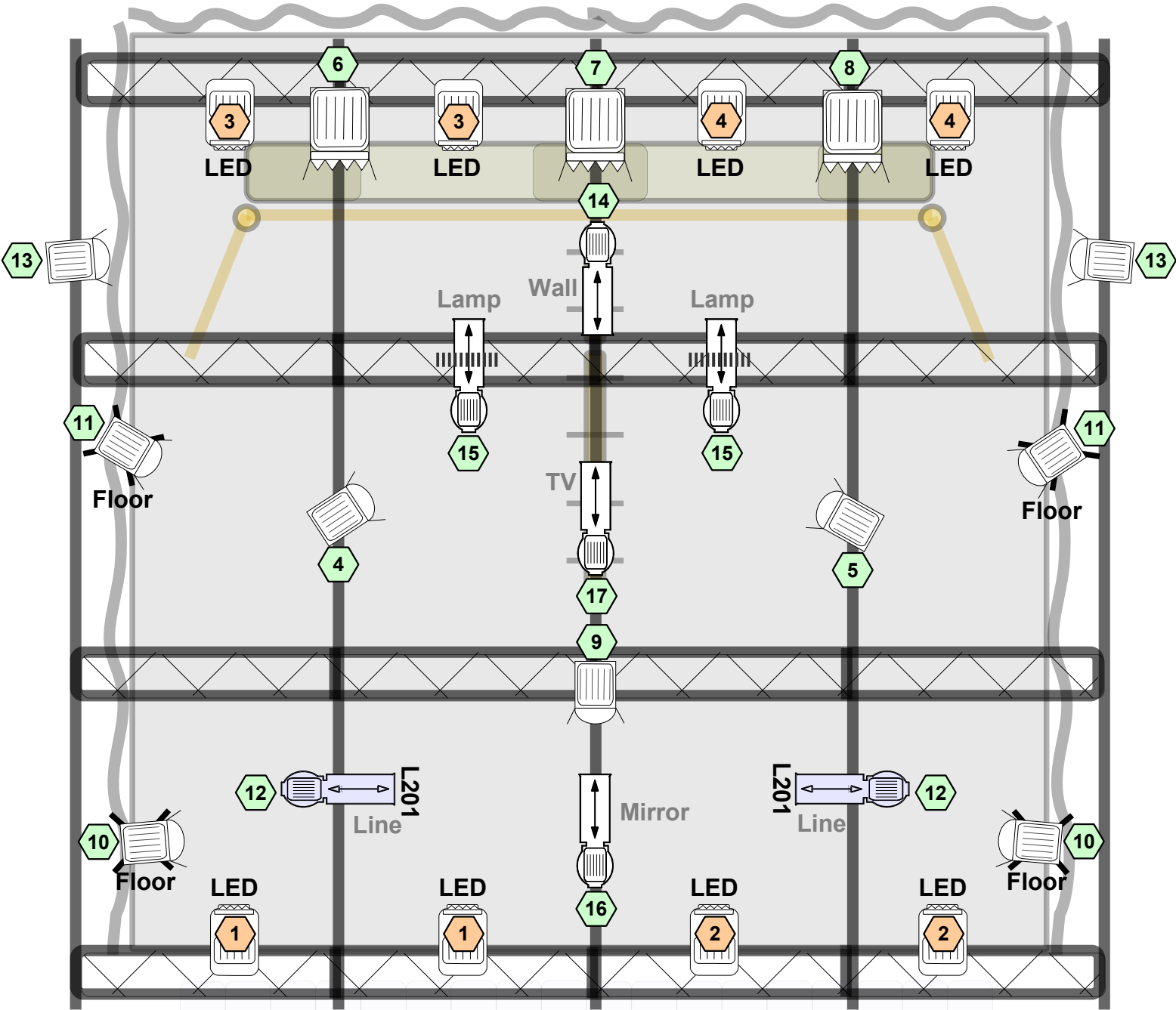

# Simorág DanCircus – Tale of the Mirror

Technical Rider (Light) Simple

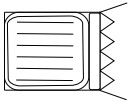

**3pcs. Fresnel 2kW**  
(with barndoor and frame)



**12pcs. PC 1kW**  
(with barndoor and frame)

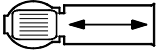

**9pcs. Profil 1kW zoom 25-50**  
(with 2x goboholder, 2x iris, 2x frame)  
■ ■ ■ ■ ■ ■    |||||



**8pcs. RGBW LED Wash**  
① (number of fixture group)



**2pcs. Symmetrical Flood** (for public)



**4pcs. Floor Stand**

**19x 2kW Dimmer channel** ①

**Compulite Spark 4D** lighting desk  
or similar programmable lighting controller  
with minimum 20 submaster